

Dunsley Heat

Burning Wood Smokeless



YORKSHIRE THE SMOKELESS STOVE

Wood-burning & Multifuel
Central Heating & Roomheating



Dunsley Products are manufactured in Great Britain

Yorkshire • No Boiler • Full Convection

How do you choose the stove to meet your requirements? We would like you to choose a Dunsley "Yorkshire" Stove - but, while you're comparing it with other models, may we suggest that you consider the following points?

The Yorkshire Stove is the only multi-fuel stove ever to have met all the U.K. clean-burning tests. It can actually burn cleaner than so called 'smokeless' fuels.

The Yorkshire will burn virtually anything. You can burn wood, coke, anthracite, bituminous coal briquettes, even brown coal and softwoods, even in smoke control areas, there's no need to change grates or throat plates, as the grate bars are adjustable making them suitable for either wood or other fuels. (The only problem for Dunsley is the grate is so well made its very seldom anyone requires a replacement bar).

Clean combustion gives you a clear view of the fire through the large self-cleaning window.

Burning the smoke as well as the fuel means more heat for less fuel. That means less ash, less refuelling and less hassle.

Just one simple control gives instant control - from as low as 2kW output up to a massive 12kW of glorious heat

YOUR CHOICE

The Yorkshire stove be it for room heating only or an automatic central heating model can be ordered either as a multifuel model or as a woodburning model. The woodburning model is less expensive but can only burn wood.

HOW IT WORKS:

In ordinary stoves, air comes up beneath the fuel, so that smoke (which is tiny particles of unburned fuel), heat and waste gases are thrown from the top of the fuel into the chimney. The Yorkshire is different - air enters above the fuel, sweeping in front of the window, forcing smoke down into the hottest part of the fire and on into a refractory-lined 'afterburn' chamber. Highly turbulent air is introduced to the hot smoke, which ignites generating temperatures of up to 1100°C. The result is not just near-zero smoke emission, but greatly improved efficiency, virtually instant controllability and a truly astonishing swirling flame pattern.

LOOK AT THIS CHART

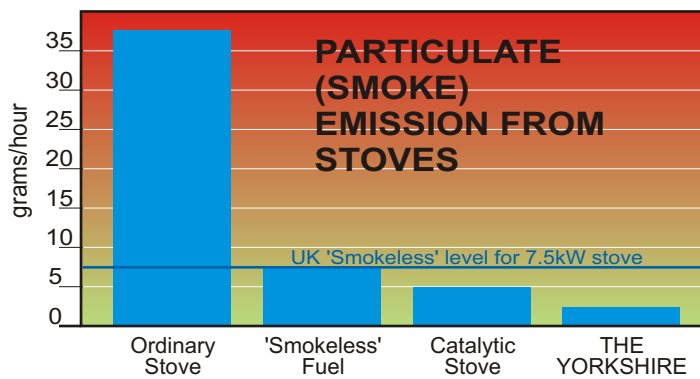

Here is the table of **maximum** heat outputs for Yorkshire models:

MAXIMUM HEAT OUTPUT UNDER TEST CONDITIONS:						
Maximum outputs	Refueling every...	BOILER MODELS				NON-BOILER MODELS
		Total	To room	To water	Efficiency	Total
Wood Logs	1½ hours	13.7 kW	4.5 kW	9.2 kW	75%	12.3 kW
Wood Logs	¾ hours	17	5.2	11.8	73.8%	13.5 kW
Ancit	4 hours	11.5	4.2	7.3	70.2%	10.3 kW
Ancit	1 hours	13.6	4.8	8.8	71.8%	11.5 kW

Other mineral fuels can be burnt
Coal Briquettes, Home Fire, Taybrite, Pureheat

STOVE SIDE VIEW, WITH FIREBRICKS, THROAT PLATE IN POSITION

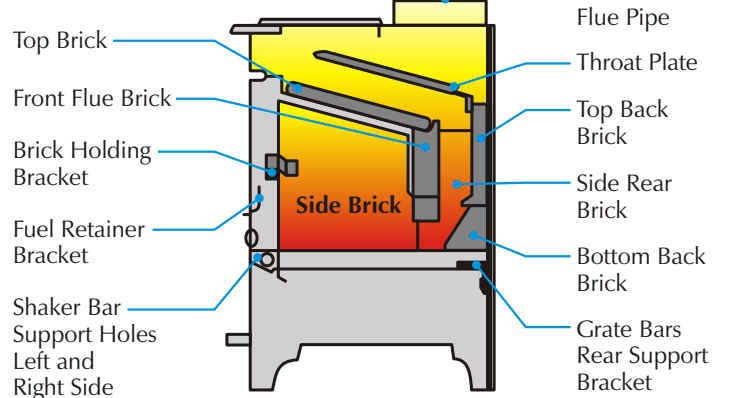

Dunsley Yorkshire - the s

Yorkshire Automatic Central Heating Boiler

SMOKELESS: The Dunsley Yorkshire Stove Boiler Model, side view showing waterways in blue uses the Downburning system where the smoke (which is tiny particles of unburned fuel) is pulled down through the very hottest part of the fire into an afterburn chamber where it burns away - giving more heat for less fuel and combustion clean enough for even the strictest smokeless zones - it's even cleaner than 'smokeless' fuels. On the boiler model air supply for combustion can be obtained from outside the building for good performance without draughts.

CLEAN & CLEAR: Clean combustion and airwash air supply means a really clear view of the flames.

EASY TO USE: Just one control for the boiler model - turn it up and it goes up, turn it down and it goes down. There are no valves or dampers to adjust.

GRATE BARS: Fitted with long life Chrome Iron multi-fuel riddling grate bars, which has two functions, to adjust the space between the grate bars making them suitable for wood or other fuels. Also agitates the firebed to remove the ash.

FUELS: The Yorkshire is approved to burn the following fuels even in smoke control areas. Dry seasoned wood - Dry peat turves - Peat briquettes "Bord na Mona briquettes" - Lignite briquettes "Union briquettes" - Wildfire coal briquettes - all authorised smokeless fuels, including Briquettes - Soft cokes - Hard cokes and Petroleum cokes.

The Yorkshire is the only stove officially U.K. approved to burn the above range of fuels in smoke controlled areas.

The Yorkshire can also burn bituminous house coal and all non authorised solid fuels outside smoke control areas with much lower smoke emission than conventional stoves.

The Yorkshire has also been approved for long burning periods of up to 10 hours (HETAS Approved test).

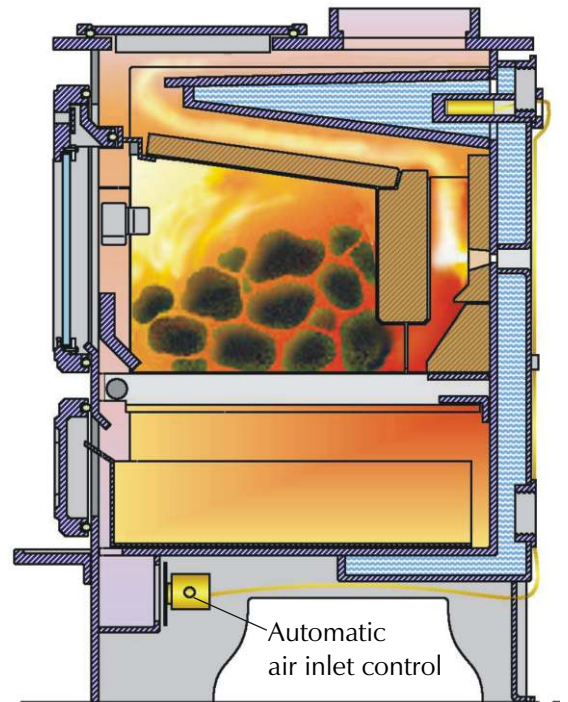

AUTOMATIC CONTROL BOILER MODEL ONLY

The Yorkshire built in thermostat automatically monitors central heating temperature and controls the incoming air to regulate how fiercely the fire burns to meet the central heating requirements.

The Yorkshire automatic central heating boiler works on it's own without any electrical connections, however electricians are required to operate the circulating pump or other electrical equipment such as time clocks, room stats etc which are fitted onto the heating system to turn the fire up in the morning, and down at night (even regulates itself to compensate for changes in the weather). Unfortunately we cannot fuel the Yorkshire for you, but throw on the fuel, remove ash as required and the Yorkshire automatic pretty much takes care of itself.

The Yorkshire with or without automatic boiler is very suitable for Woodland areas as it will burn soft wood or hard wood continually, even in smoke controlled areas.

Dunsley also has available for boiler model, external air intake which allows combustion air to be taken from outside the building, if this method is used no extra air vents into the room where the Yorkshire Stove is installed are required. See accessories on rear page.

Installation instructions and prices are available on request.

	BOILER MODELS	NON-BOILER MODELS
Width	595mm	540mm
Height (excl. 45mm flue socket)	715mm	705mm
Depth excl. 70mm front projection	450mm	415mm
Weight	198kg	142kg
Typical flue gas temperature	285°C	300°C
Typical flue gas flow rate	13.5 g/sec	13.5 g/sec
Water content	22 litres	—
Water connections	4x1" BSP Internal	—
Maximum operating pressure	2.5bar	—
Typical actual efficiency	75%	71%
Minimum Flue Draught	15pa / 0.15mbar / 0.06 insH ₂ O	
Firebox effective volume:	Mineral Fuel: 0.0158m ³ Wood logs: 0.0210m ³	
Maximum fuel load	Anthracite: 14kg Wood logs: 8.0kg	
Construction conforms to:	EN13240:2001	

stove that doesn't smoke

Keep your gas/oil costs down. Install a Dunsley Stove with or without boiler.
Remember wood is a renewable fuel, it just keeps growing.

Research and development of the Yorkshire Stove's clean-burning combustion system was partly funded under European Union environmental protection schemes.



THE UNIVERSITY of LIVERPOOL

Analysis of gas dynamics and physical flow modelling of the Yorkshire Stove's combustion chamber carried out by the University of Liverpool.



Smoke emission certification supervised by AEA Technology on behalf of HM Government
www.aeat.com

Certification to British Standards



by HETAS www.hetas.co.uk



Hughes Design

Appliance design by Glyn Hughes
www.btinternet.com/~glynhughes

'T-Khrom' alloy specially developed for the Yorkshire grate by Stove Castings Ltd.
www.stovecastings.co.uk

Many stove manufacturers are claiming "Clean Burn". This does not mean they are approved appliances. If you live in a smoke control area you should make sure the stove you install is an officially U.K approved appliance for the fuels you wish to burn.



Exempted Fireplaces

The Smoke Control Areas (Exempted Fireplaces) Order 1999
The Smoke Control Areas (Exempted Fireplaces) Order 2005

The Dunsley Yorkshire Stoves

Have been approved by Defra and the devolved administrations for use in smoke control areas in the United Kingdom and are exempt from the section 20 of the Clean Air Act 1993 when:

1. Installed, maintained and operated in accordance with the manufacturer's instructions.
2. No fuel shall be used other than:

Wood-Burning Stove and Wood-Burning Stove with Boiler: (a) untreated dry wood.
Multifuel Stove, and Multifuel Stove with Boiler: (a) untreated dry wood, (b) peat or peat briquettes, (c) Union Coal Briketts, (d) CPL Wildfire bituminous coal briquettes, or any approved smokeless fuel.

ACCESSORIES AVAILABLE ON REQUEST

All measurements in millimetres

External Air Intake (Boiler Model)	Part No 02044
Decorative Window Trim	Part No 02041
Ash Container	Part No 01414
Fuel Carrier	Part No 01429
Griddle	Part No 02039
Trivet	Part No 02040



Decorative Window Trim in position
Part No. 02041

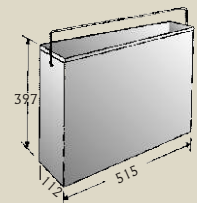

Multi-Fuel Ash Container Part No. 01414

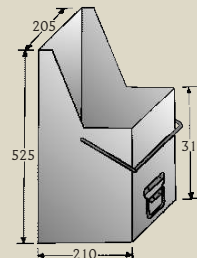

Fuel Carrier
Part No. 01429

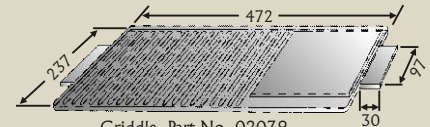

Griddle. Part No. 02039

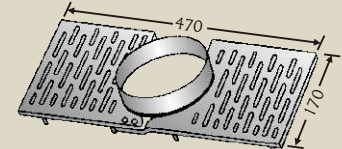

Trivet. Part No. 02040

SEE ACCESSORIES: The Griddle fits on top of the hot plate, ideal to griddle your steak, bacon, sausage, chops etc. The Trivet fixes at each side of the flue, held in position by two screws and raised slightly from the stove top to provide an area at the rear of the hot plate or griddle to keep food or coffee warm.

The hot plate on the Yorkshire has been specially designed with heat collecting ribs on it's underside to give you a superb area for heating or even cooking a variety of foods, perfect for your coffee or tea pot. Also helps to ease the worry if your gas or electricity fails.



It's quality that counts

GUARANTEE

Backed by the Dunsley
3 year guarantee in addition
to your statutory rights.

Dunsley has been Designing and Manufacturing superior solid fuel heating equipment for over 50 years.
Dunsley Heat Limited, Bridge Mills, Huddersfield Road, Holmfirth, Huddersfield HD9 3TW, England
Tel: 01484 682635 Fax: 01484 688428 email: sales@dunsleyheat.co.uk
Web Site: www.dunsleyheat.co.uk

Dunsley are continually reviewing products and may make alterations without notice